



KOSHINPUMP.COM

HIDELS PUMP

High Performance Self-Priming Engine Pump

OPERATION MANUAL

《SEM-25L》

- Thank you for purchasing KOSHIN HIDELS PUMP.
- This manual is prepared for your safety when operating pump. Please read carefully and comprehend fully before use. (Wrong usage could cause injury or death.)
- Please keep this manual handy for future reference.

**Please read this manual and engine manual
before operation.**

KOSHIN LTD. www.koshinpump.com

12 Kami-Hachinotsubo Kotari, Nagaokakyo City, Kyoto 617-8511 JAPAN
TEL.+81-75-954-6111 FAX.+81-75-954-6119

CAUTION

1. Application

As this pump is exclusively used for agriculture, do not apply muddy water.

- * Trouble if you don't observe.
Damage of mechanical seal

2. Priming

As this pump is of self-priming type, pour water fully from priming port before running.

- * Trouble if you don't observe.
Impossible pumping
Damage of mechanical seal

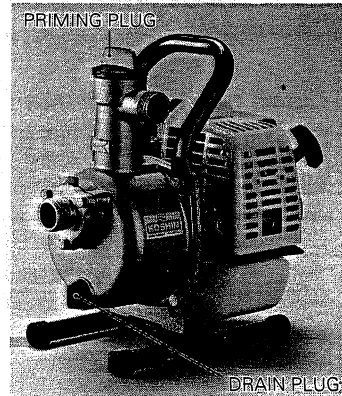

3. Fuel supply

Fill the fuel tank with the fuel. Be sure to stop the engine before supplying the fuel.

Fuel to be used; Mixture of oil and gasoline mixed at the ratio of 25 (lead-free gasoline) : 1 (oil). However, for the first 20 hours of operation, the gasoline and lubrication oil mixed at the ratio of 20 (lead-free gasoline) : 1 should be used to smooth the operation of engine.

When the quality of mixed oil is low, the ignition plug is contaminated excessively and an increased amount of carbon accumulates in the muffler and cylinder. Be sure to use the oil specially made for 2 cycles and sold by each petroleum maker in the commercial market.

4. Connection of suction hose

If priming is not made by running after pouring water from priming port, it is almost because of imperfect connection of suction hose. In such a case, run after checking again connection of hose.

- * Trouble if you don't observe.
Impossible pumping

5. Drain of water after use

Water inside casing freezes at below 0°C in winter and thereby pump may possibly be broken. After use, drain water from drain port at bottom to store.

- * Trouble if you don't observe.
Breakage of pump casing

PARTS LIST

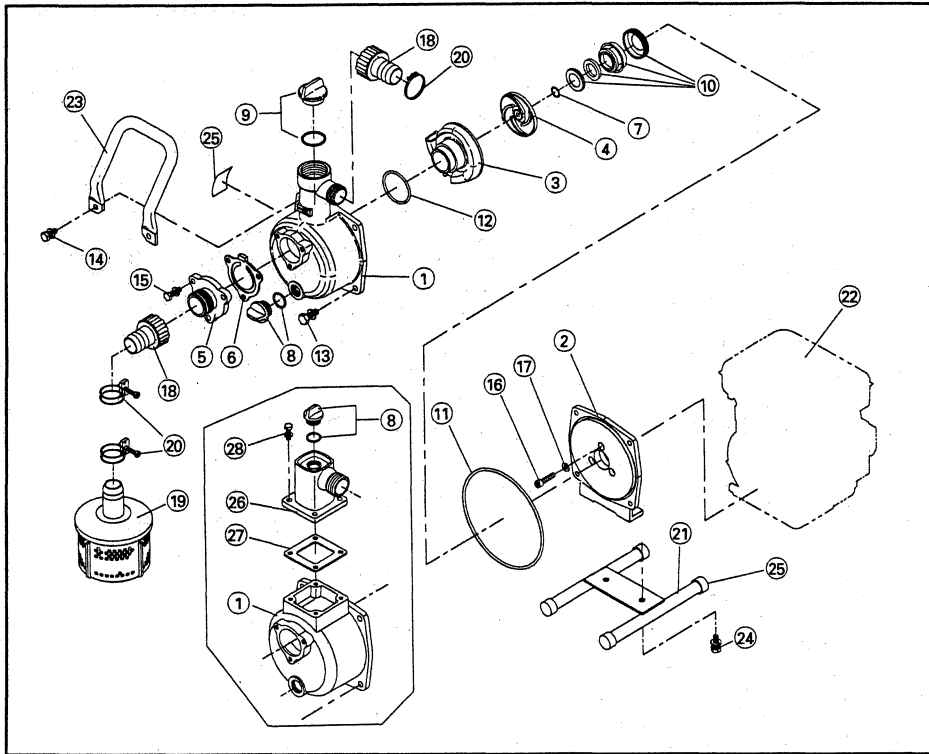

No.	PARTS No.	PARTS NAME	QTY	REMARKS
1	0113329	Pump casing	1	ADC
	0113977	Pump casing	1	SEM-25L-BAE
2	0115987	Flange bracket	1	ADC
3	0115986	Volute casing	1	ADC
4	0115985	Impeller	3	ADC
5	0113325	Suction flange	1	ADC
6	0113326	Check Valve	1	NBR
7	0113944	Adjusting washer	1	BS
8	0148010	Plug set	1	15A
	0148010	Plug set	1	SEM-25L-BAE
9	0118450	Plug set	2	32A
10	0116054	Mechanical seal	1	EA560-12
11	890255031	O-Ring 1517-31	1	1517-31
12	889855042	O-Ring	1	P42 NBR
13	743119045	Bolt	2	M8x20

No.	PARTS No.	PARTS NAME	QTY	REMARKS
14	743119046	Bolt	2	M8x22
15	743119032	Bolt	3	M6x20
16	734532274	Socket bolt	3	M5x40
17	854255005	Seal washer	3	φ 5
18	0348214	Coupling set	2	
19	0118193	Strainer	1	
20	940019032	Hose band	3	φ 32
21	0118267	Base set	1	
22	—	Engine	1	TU26
23	0114277	Handle	1	
24	743119043	Bolt	2	M8x16
25	0112576	Pipe rubber	4	
26	0110486	Delivery flange	1	
27	0110487	Flange packing	1	
28	743119032	Bolt	4	M6x20

6. Long storage

Discharge fuel in fuel tank and carburetter entirely.

* Trouble if you don't observe.

Impossible to start engine (With regard to engine, refer to instruction manual of engine.)

7. Avoid water hammer

Don't step on the discharge hose or abrupt valve operation.

Trouble if you don't observe.

Breakage of pump casing.

DAILY AND ROUTINE CHECKS

· DAILY CHECK

Make the following daily checks without fail before starting Pump.

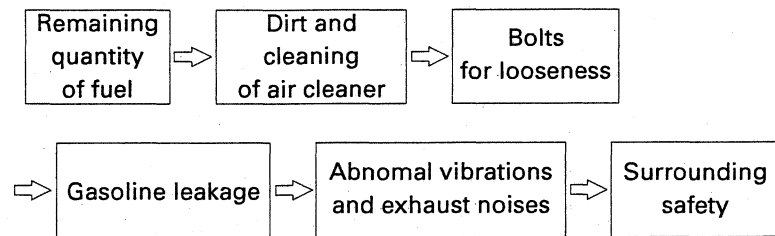

· ROUTINE CHECK

perform maintenance and checks according to the following check list (when the engine is employed under ordinary conditions) to maintain the engine in good operating conditions.

	8 hours (daily)	50 hours (weekly)	200 hours (monthly)	500 hours	1000 hours
Clean engine and check bolts and nuts.	○(daily)				
Clean spark plug.		○			
Clean air cleaner.		○			
Remove the pump casing and clean			○		
Clean and adjust spark plug gap.			○		
Clean fuel strainer.			○		
Clean and adjust carburetor.				○	
Clean fuel tank.				○	
Overhaul engine.				○	○

CAUTION: Replace rubber pipes for passage every two years. If and when fuel leakage is found, replace pipe at once.

Preparation before engine pump operation

1. WATER

- Remove priming plug and add water until pump casing is filled up with water.

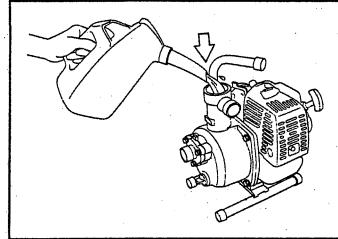

Caution : Dry running without water may cause damage of mechanical seal.

2. HOSE INSTALLATION

- a. Install the hose joints on the pump.

Caution : When installing the joint to the pump, be sure the gasket is in place.

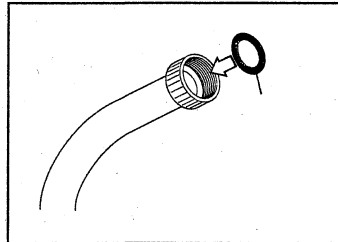

- b. Connect the hoses on the joints with band.

Note : Should air leak, water will not be drawn up.

- Important :
- a. Use hard suction hose.
 - b. Connect the suction hose certainly and tightened with coupling and hose band.
 - c. Connect the strainer to the suction hose end.

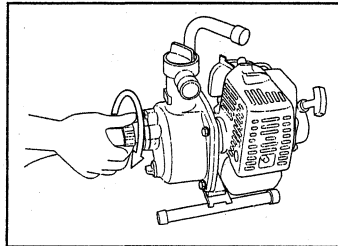

3. FUEL REPLENISHMENT

- ⚠ Attention :
- a. Never refuel while smoking or in the vicinity of an open flame.
 - b. After refueling, make sure the tank cap is tightened securely.
 - c. Before refueling, be sure to stop engine. Leave it more than 2minutes for cooling-off.

Notes : Use the mixture fuel prepared by mixing gasoline and exclusive 2-cycle oil at ratio of 20~25 : 1, or the 2cycle fuel now available on the market.

SPECIFICATION

TYPE		SEM-25L
PUMP	Connection Dia	25 m/m (1")
	Connection Thread	Outer Pipe Thread
	Total Head	35m (115Ft)
	Delivery Volume	115 ℓ /min (30 u.s.g./ min)
ENGINE	Model	Forced Air Cooling 2 cycle Gasoline Engine MITSUBISHI TU26
	Exhaust Volume	25.6 c.c.
	Horse Power	Max 1.03kw (1.4ps) / 7500 r.p.m.
	Fuel	2 cycle Mixed Gas and Oil
	Fuel Tank Capacity	Abt 0.6 ℓ
	Fuel Consumption Hour (full tank)	Abt 50 min
	Starting Method	Recoil Starter
Net Weight		5.0 kg
Standard Accessories		1 Strainer 2 Hose Couplings 3 Hose Bands 1 Engine tool Set

PERFORMANCE CURVE

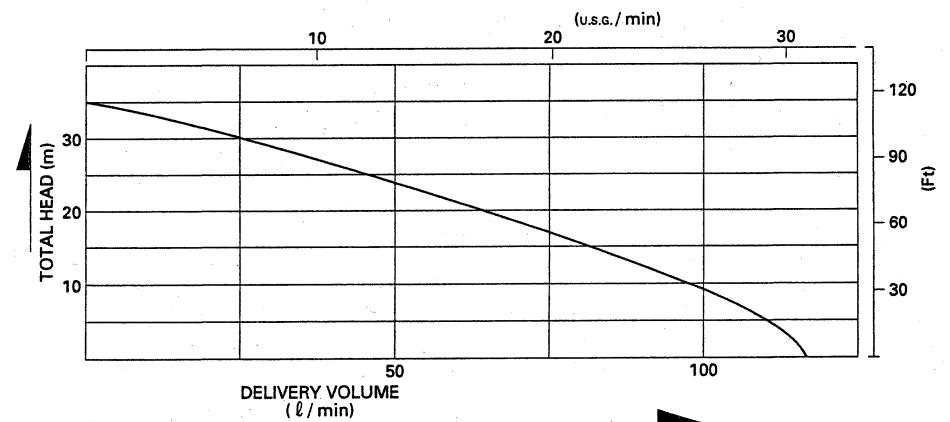

PREPARATION FOR LONG STORAGE

LONG TERM STORAGE

- Drain fuel from the fuel tank, the fuel cock and the carburetor.
- Feed 5~6cc of motor oil into the spark plug hole.
- Pull the recoil starter rope until it feels heavy.
(This prevents the cylinder and valves from rusting.)
- Drain water from the pump completely.
- Place a cover on the engine to protect it from dust and dirt.

TROUBLE & REMEDY

- | | |
|---------------------------|---------------------------------------------------------------------------------------------------------------------------------------------------------------------------------------------------------------------------------------------------------------------------------------------------------------------------------------------------------------------------------------------------------------------------------------------------------------------------------------------------------------------------------------------------------------------|
| Pump does not revolve. | <ul style="list-style-type: none"> — Rusting inside engine
(Refer to instruction manual of engine) — Burning of engine
(Refer to instruction manual of engine) — Sticking of impeller
(Disassemble & clean) |
| Pumping volume is small. | <ul style="list-style-type: none"> — Entrance of air at suction side
(Check piping at suction side) — Drop of engine output
(Repair) — Breakage of mechanical seal
(Replace mechanical seal) — High suction lift
(Lower) — Thin or long or kink of hose
(Thicken or shorten or straighten) — Leak of water from water passage
(Stop leak) — Clogging of foreign substance in impeller
(Disassemble & clean) — Wear of impeller
(Replace impeller) |
| Pump does not self-prime. | <ul style="list-style-type: none"> — Suction of air at suction side
(Check piping at suction side) — Insufficient priming water inside pump casing
(Prime fully) — Imperfect tightening of drain cock
(Tighten) — Imperfect revolution of engine
(Repair engine) — Entrance of air from mechanical seal
(Replace mechanical seal) |

4. STARTING

1. To start the pump turn on the engine switch.
2. Press the priming button repeatedly with a finger till it touches the top. (In order to pump up the fuel and ensure a smooth start.)
3. Move the choke lever to the fully closed position. (Lift up the lever upwards)
When fuel is remaining and the engine is warm, move choke lever to the fully open position. (Pull down the lever.)
4. Move the throttle lever to the position near the center between the low speed and high speed position.
5. Grasp the recoil starter knob and pull it rapidly.
6. After starting, watch the engine condition and move the choke lever slowly to the full open position. (Pull down the lever.)

Note: When the explosion sound is heard, but the engine does not start, move the choke lever to the full open position and again pull the starter knob rapidly.

This engine is of construction that the fuel returns to the fuel tank when the priming pump is operated. Even if the pump is operated a little too much, the fuel will not be pumped up excessively, it should be operated sufficiently. Because, when it is insufficient starting trouble may be raised.

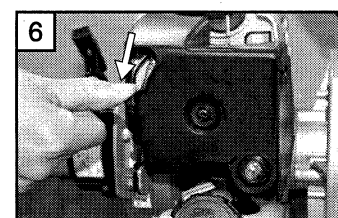
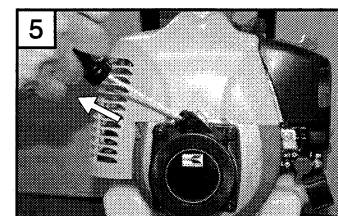
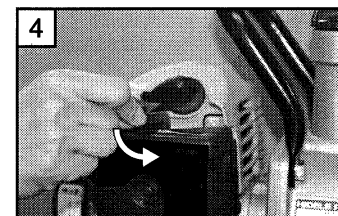
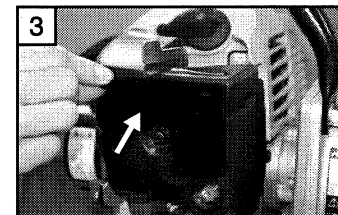
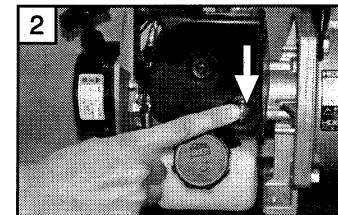
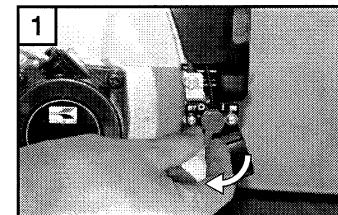

STOPPING ENGINE

1. Move the throttle lever to the low speed position.

2. Depress STOP BUTTON and hold down until engine stops.

Note: Do not stop engine suddenly while running at high speed.

- Should refuel before all fuel consumed in order to ensure a smooth restart.
- For storage, drain fuel from the fuel tank, the fuel cock and the carburetor, and start the engine until the remained fuel in the engine consumed.

Attention: During summer when the engine is stopped for rest, place on the horizontally flat, be careful that the inner packing of tank cap is not submerged in the fuel as shown on the right illustration.

If the air hole submerged in the fuel, the fuel may leak due to the increase inner pressure in the fuel tank.

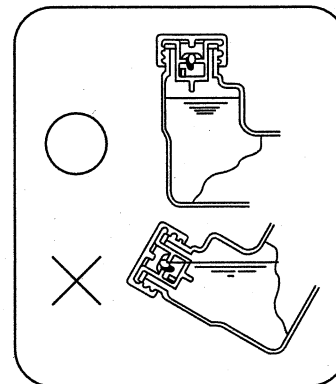
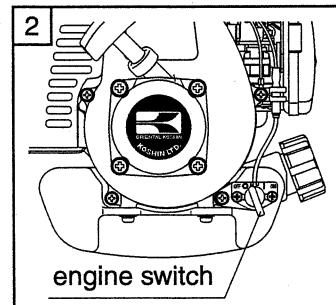
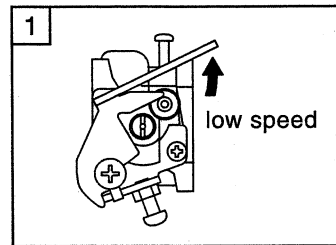

Operation

- After engine start, move the throttle lever to low speed position and warm up the engine for about one minutes. As the engine become warm, smooth acceleration will be obtained.

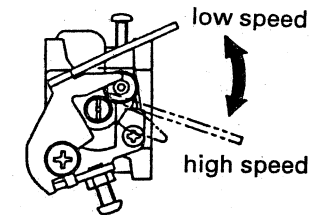

- Since every part of the engine is not well lubricated just the starting, avoid increasing the engine revolution rapidly.
- When the throttle is in full open position, the engine revolution becomes considerably high, and that not only gives a bad effect on the engine life but also cause the engine failure.

Carburetor adjusting

Revolution of the engine is already adjusted in best condition before delivery. Do not adjust revolution unless engine does not work well.

- Use the low speed adjusting screw to adjust low speed revolution
 - Right Turn : increase revolution
 - Left Turn : decrease revolution
- Low speed fuel adjusting screw
 - Standard : Fully close (Right turn) and reverse (Left turn) 1 rotation.
 - Right Turn : fuel become thin
 - Left Turn : fuel become thick

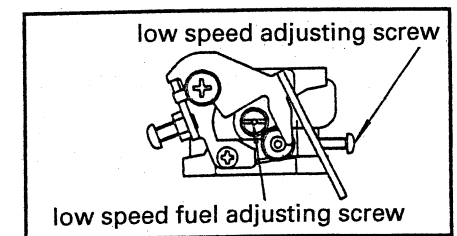

Carburetor is already adjusted in best condition before delivery.

