

DWG No.012889306 MODEL:SER-40EX FORM:SER-40EX-BAA-1(EX17)

No.	PARTS CODE	PARTS NAME	QTY	MATERIAL/SIZE	REMARKS
1	0122155	PUMP CASING	1	ADC	
2	0114003	SER-40 SUCTION FLANGE	1	ADC	
3	0112799	CHECK VALVE	1	NBR	
4	0118079	25A PLUG SET	1		
5	0110568	FLANGE BRACKET	1	ADC	
6	0112818	VOLUTE CASING	1	FC-20	
7	0112861	IMPELLER	1	FC-20	
8	0110721	SER-40 DELIVERY FLANGE	1	ADC	
9	0110584	FLANGE PACKING	1	CR	
10	0117933	SER-40EX BASE SET	1	NO.240	
11	0110491	IMPELLER ADJUSTING WASHER	3	BSP1 T0.3	
12	0121395	EX170DM2210ENGINE (EX17)	1		
13	0110863	MECHANICAL SEAL	1	HG9A-MN(H)φ 2 0	
14	0117212	COUPLING SET	1		
15	0114986	COUPLING	1	PC	
16	0110358	HOSE NIPPLE	1	ABS	
17	0114987	COUPLING PACKING	1	NBR	
18	0117026	COUPLING SET	1		
19	0113390	COUPLING	1	ABS	
20	0110356	HOSE NIPPLE	1	ABS	
21	0113391	COUPLING PACKING	1	NBR	
22	0118047	SER-40 STRAINER SET	1		
23	940019060	HOSE BAND	2	φ 60	
24	940019048	HOSE BAND	1	φ 48	
25	0120255	NAME PLATE	1		
26	0115016	O-RING 1517-51.5	1	1517-51.5 NBR	
27	0113989	O-RING P74	1	P74 NBR	
28	743119061	BOLT	3	M10×25 SWRM	
29	743119078	BOLT	4	M12×30 SWRM	
30	743119063	BOLT	4	M10×30 SWRM	

◆ Bare engine can not be supplied

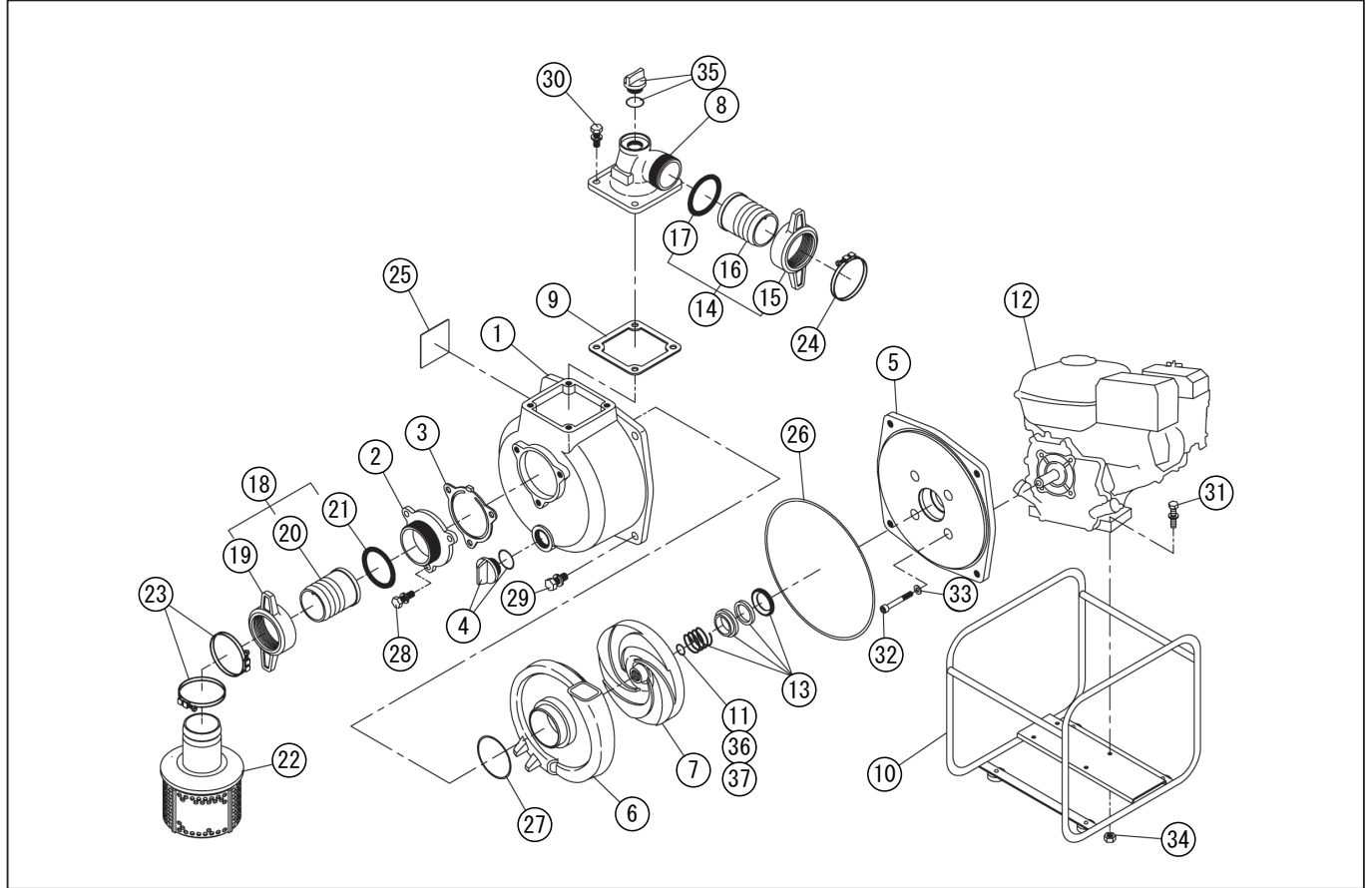

DWG No.012889306 MODEL:SER-40EX FORM:SER-40EX-BAA-1(EX17)

No.	PARTS CODE	PARTS NAME	QTY	MATERIAL/SIZE	REMARKS
31	743119053	BOLT	4	M8×40 SWRM	
32	734532076	SOCKET BOLT	4	M8×60 SCM CS	
33	854255008	SEAL WASHER	4	φ8	
34	827419008	NUT	4	M8 SWRM	
35	0118078	20A PLUG SET	1		
	0114718	CE MARK LABEL	1		
	0114713	CAUTION LABEL	1		
	0114818	DECLARATION	1		
	0116412	EU LABEL(106)	1		

◆ Bare engine can not be supplied